

Article number: 435700016

Description: Rota-fix shaft-hub connection K 16x32

Note: Self centering. Medium torque

## Measures

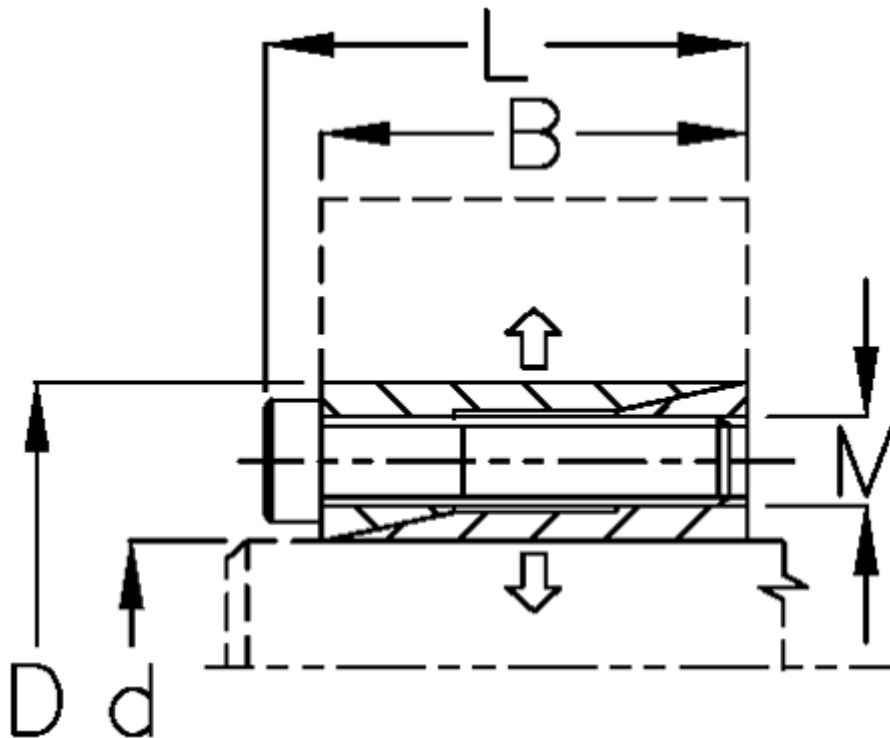

B mm	= 17
d mm	= 16.00
D mm	= 32
Fit tolerance	= Aksel h8, Nav H8
F kN torque	= 8.0
L mm	= 21.0
M mm	= M4
P N/mm <sup>2</sup> surface pressure on shaft/hub	= 65

Surface roughness	= R? ? 3.2 µm
T N m torque	= 70
Ts N m bolt tightening torque	= 4.9